

Article number: 51835203100010

Description: Vibration damper VIBR M0050

Measures

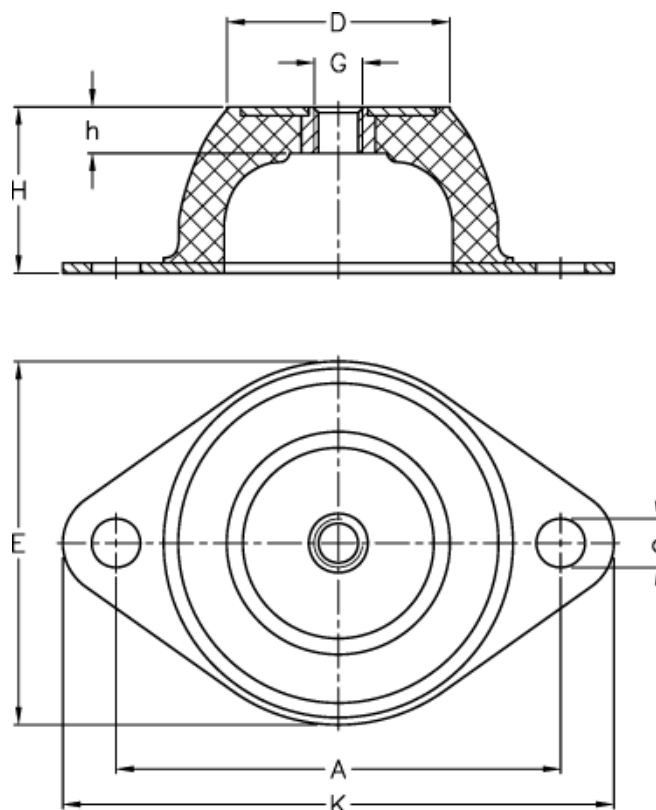

A = 92

Max. (kg) 40 degrees C = 40.0

D = 45

Max. (kg) 60 degrees C = 80

d = 10.0

E = 76

G = M10

H = 35

h = 14

K = 114